

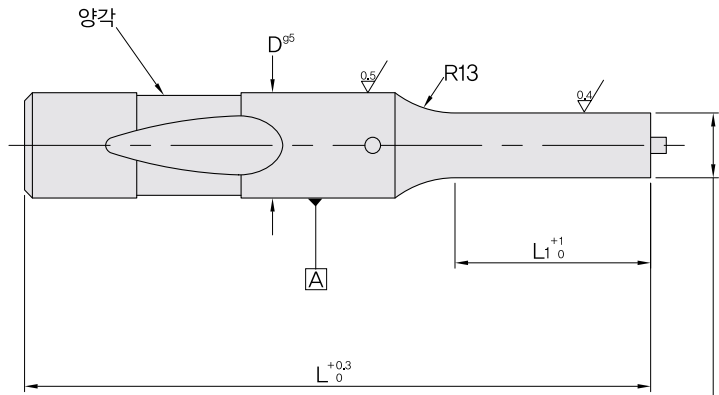

# PUNCH - LJ\_ BALL LOCK EJECTOR PUNCH

## TYPE LJ\_ (경하중용)



원형  $P^{+0.01}_0$   
 이형  $W^{\pm 0.01}$

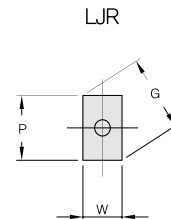
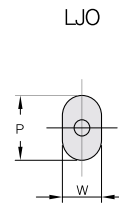
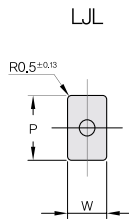
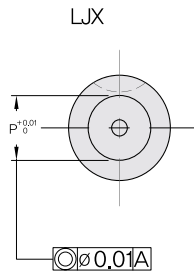
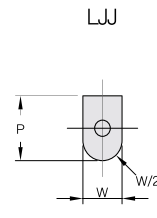
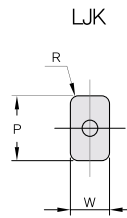
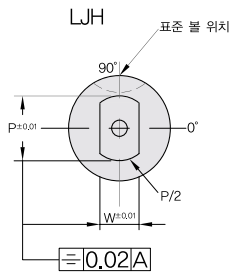

\*  $P \geq W$   
 \* R=지정가능  
 \*  $G = \sqrt{P^2 + W^2}$



# PUNCH - LJ\_ BALL LOCK EJECTOR PUNCH

호칭경 D	Std. S	L1 Alt. A	Alt. B	Type&D	원형 P	Type&D	이형 min. - max. W P/G	L				
								63	71	80	90	100
06	13	10*	-	LJX06	2.10-5.97	LJ_06	2.10-5.97	●	●	●	●	●
10	19	10	-	LJX10	2.10-9.97	LJ_10	2.10-9.97	●	●	●	●	●
13	19	13	25	LJX13	5.00-12.97	LJ_13	4.50-12.97	●	●	●	●	●
16	19	13	25	LJX16	8.00-15.97	LJ_16	6.00-15.97	●	●	●	●	●
20	19	13	25	LJX20	12.00-19.97	LJ_20	8.00-19.97	●	●	●	●	●
25	19	13	25	LJX25	16.00-24.97	LJ_25	10.00-24.97	●	●	●	●	●
32	19	13	25	LJX32	24.97-31.97	LJ_32	12.97-31.97		●	●	●	●
38	25	19	30	LJX38	30.00-37.97	LJ_38	14.00-37.97			●	●	●

\* Min P or W = 1.60 when L1 = 10

규격표기 방법	Catalog No.	D	-	L1	-	L	-	P,W
	LJX	16	-	19	-	80	-	P8.0
	LJR	16	-	25	-	80	-	P8.5, W8.0